

**ACCIDENTS OF MOTOR CYCLISTS
INCREASE OF SAFETY BY TECHNICAL MEASURES ON THE BASIS OF
KNOWLEDGE DERIVED FROM REAL-LIFE ACCIDENTS**

M. Danner, K. Langwieder, A. Sporer

HUK-Verband

Automobile Engineering Department

German Association of Third Party, Accident,
Motor Vehicle and Legal Protection Insurers

Tenth International Technical Conference
on Experimental Safety Vehicles (ESV)
Oxford
July 1985

**ACCIDENTS OF MOTOR CYCLISTS
INCREASE OF SAFETY BY TECHNICAL MEASURES ON THE BASIS OF
KNOWLEDGE DERIVED FROM REAL-LIFE ACCIDENTS**

M. Danner, K. Langwieder, A. Sporer

HUK-Verband

Automobile Engineering Department

German Association of Third Party, Accident,
Motor Vehicle and Legal Protection Insurers

ABSTRACT

Technical safety measures call for a detailed knowledge of how accidents occur; accidents involving two-wheel-vehicles pose particular problems in describing the course of the accident and injury severity as well as in ascertaining the causes.

Using a material covering ca. 3500 accidents with motorized two-wheelers a realistic classification-system is explained, and the problems of the different two-wheel-categories are shown.

Experimental and mathematical simulations of the main accident-type lead to some suggestions how to change the motorcycle resp. to add some safety-elements to reduce the injury risk of the driver.

A safety-motorcycle is introduced which can improve the flight-path of the driver after an impact positively without being unrealistic.

INTRODUCTION

The safety research concerning motorcycles has, compared with motor-car research, only begun. Especially therefore it is important not to aim at general solutions, but to find the main causes of accidents after analysing the characteristic features of accidents. Only then it will be possible to search for improvements resp. new safety elements which will reduce the motorcyclist's risk of being injured and which will make motor cycling safer in the future.

In the beginning of the 70ies one of the first institutions who began to systematically record and evaluate the motorcycle accident was the HUK-association. This started in a time when the number of motorcycles was lower than ever. Compared: in 1972 there were 198.221 motorcycles, in 1984 the number was 946.572. This early research made it possible to utilize a fundamental basis of accident analysis and of experimental simulation which puts us into a position of introducing sensible technological measures concerning the decrease of injuries.

So far more than 3.500 motorcycle accidents have been evaluated and recorded in EDP data files by HUK-engineers. These accidents mark the starting position for further experimentation and mathematical models. The development of accidents in which motorcycles were involved shows, after a very steep increase until 1982, a continuous downward trend (Figure 1). The number of accidents, with motor-assisted bicycles and motor-assisted bikes with kick-starter has been decreasing, too. Only the number of accidents with light motorcycles has been increasing in the last few years. This is mainly due to the adolescent cyclist beginners conduct.

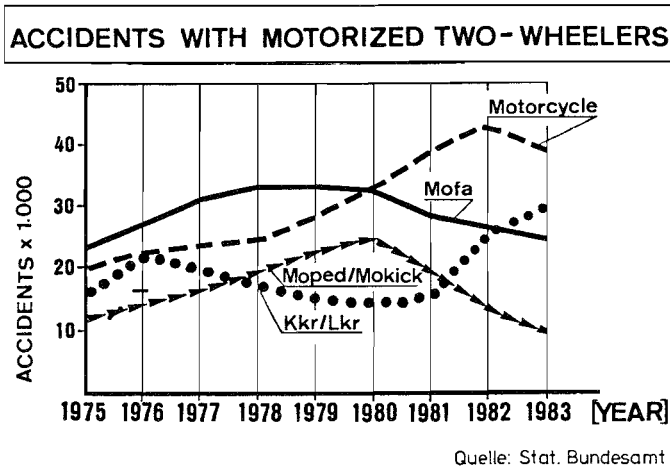

Figure 1

Nevertheless, there were still 1.548 fatally and 30.544 seriously injured cyclists in 1984. So we have to keep on trying to achieve more safety.

TECHNOLOGICAL STATUS QUO

The demonstration of the accident numbers has clearly shown that it is not very sensible to evaluate motorcycle

accidents invariably and generally. To give a better idea the main distinguishing features have been summarized (Figure 2).

MOTORIZED TWO-WHEEL VEHICLES IN WEST-GERMANY

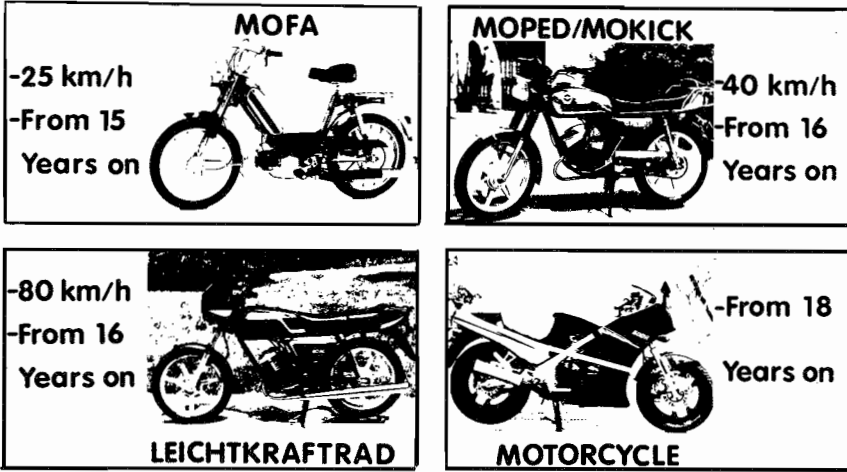

Figure 2

At present there are four different types of motorcycles in the FRG.

- 15 year-olds can drive a motor-assisted bicycle not faster than 25 km/h.
- 16-years-olds can choose between the motor-assisted bicycle with kick-starter (not faster than 40 km/h) or the " Leichtkraftrad " (80 km/h)
- From 18 on you can drive any motor-cycle without any limits to the power, apart from the producers' voluntary limitation to 100 hp.

The planned introduction of a graded driving licence will divide the motor-cycles into the following categories:

- beginners' motor cycles up to 20 kW power
- motor-cycles with unlimited power.

There are characteristic accidents in each group of cycles, one has to make differences especially between the light-powered-motor-cycles and the heavy ones. It is the exact knowledge of these sequences of motion which is the requirement for the acquisition of realistic safety conceptions.

PROBLEMS WITH LIGHT-POWERED-MOTOR-CYCLES

From an extensive study on 1.700 accidents with motor-assisted bicycles /1/ and from a special analysis of 1.000 accidents with "Leichtkrafträdern" /2/ can be seen that a main factor is to be found in the adolescent driver and his conduct. Lack of experience and a high readiness to take risks lead to driving manoeuvres often resulting in an accident. Adolescents driver beginners often recognise critical situations too late.

A further aspect limits the possible technological improvements. The design of motor-assisted bicycles and motor-assisted bikes with a kick-starter (Mofa, Moped, Mokicks) hardly permits additional parts on the cycle, as they are constructed with the lowest possible weight to achieve a competitive power. Furthermore, safety devices if they are to fulfil their function, have to have a certain solidity, which, on the other hand, is difficult to obtain on a light frame.

As we will show in another paragraph, this is especially true for side collisions, which are predominant with smaller motor-cycles.

This result leads to the conclusion that there will be only limited success as far as the realization of technological safety measures for light motor-cycles is concerned.

On the other hand, by no means all safety reserves known have been realized so far. Starting points for improvements can be found concerning e.g. the pedals of the motor-assisted bicycle which have been proved to lead to a higher risk of falling than foot rests. Further improvements might be made concerning the lighting equipment and the frame stability of the cycles. But also antimanipulation-measures, which make it impossible to increase the power and the speed are among the desirable technological measures, which are known, but not yet fulfilled.

ACCIDENT CHARACTERISTICS OF MOTORCYCLES

The analysis of accidents of all motor-cycles reveals sensible starting points, especially for heavy motor-cycles, to influence the risk of injuries by technological measures. But first the main characteristics have to be described, which are typical of the motor-cycle accident. Generally one can distinguish between single-vehicle accidents and collisions. The single-vehicle accident is presently being examined in research and some possibilities can be seen already how to take a technological influence on the single-vehicle accident and also on the mechanism of injuries during the fall.

As far as the collisions are concerned there are, apart from the rare glance off collisions, two completely different accident sequences (Figure 3)

- The collision of the vehicle involved against the motor-cycle
- the collision of the motor-cycle against the other vehicle.

COLLISIONS WITH TWO-WHEELERS

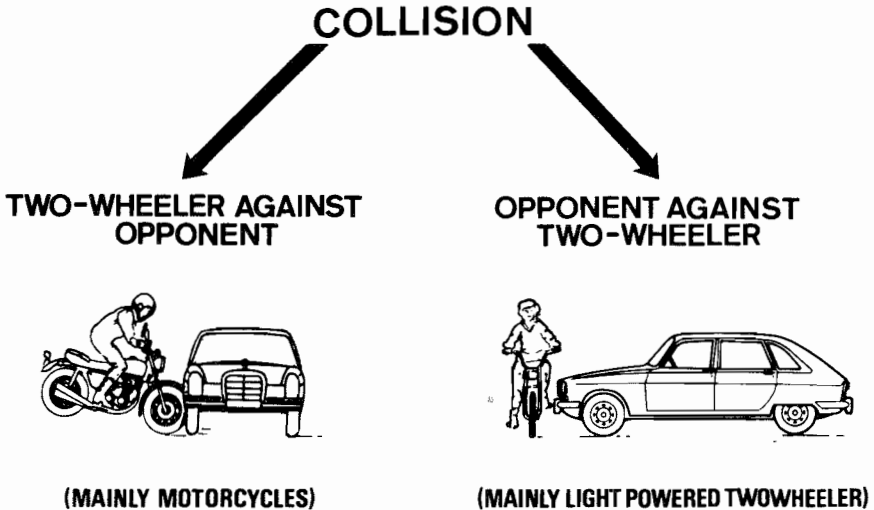

Figure 3

In the first case the motor-cyclist is impacted and run over by the other vehicle. The cyclist's kinetic energy is of less importance and the sequence of motion is, in some respects, similar to that of an accident with pedestrians. In most cases the casualty is caught by the other vehicle, is hurled onto the bonnet and eventually dropped. The injuries result mainly from the contacts with the other vehicle and are in first approximation proportional to its kinetic energy and shape aggressiveness. In other words, the faster and the more edged the other vehicle is, the more serious the cyclist's injuries are. This type of collision, happens most often with the lighter motor-cycles, such as the motor assisted bicycle and the Moped/Mokick. Effective protective devices are, as already mentioned, only very difficult to be realized, particularly as the light construction of these cycles does not permit a heavy protective bar in the area of the lower extremities.

In the second case, the collision of the cyclist against another vehicle, the accident sequence is completely different. Here the cyclist's speed and thus his kinetic energy is the central parameter for the motion path and the severity and kind of injuries. In addition, the motorcycles and light motor

cycles can be found in this group, and thus the requirements for the realization of technological measures are fulfilled.

Especially the expensive and heavy touring motor cycles are ideally suitable for safety elements without giving up the characteristics of a motor cycle. Besides these promising prospects concerning technology the relative frequency of this accident type - motorcycle against other vehicle - was a reason to deal more thoroughly with these problems. The following slide from a another research-project of the HUK-association /3/ shows that clearly (Figure 4).

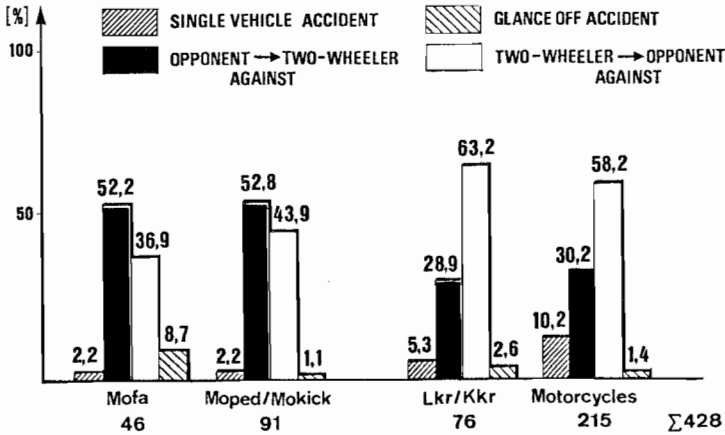

Figure 4 Distribution of Motorcycle-Main-Accident-Types

About 60% of all accidents with motor-cycles and "Leicht-krafträdern" belong to the category "motor cycle bumps against other vehicle". As for motor-assisted bicycles and Mokicks this accident type is only one third.

These are two reasons in favour of a closer examination of this accident prospects sequence, these are the frequency and the promising prospects for technological measures.

ACCIDENT SEQUENCE

In order to find the starting points for future safety elements this collision sequence, that is the bump of a motor cycle against another vehicle, has to be cut up into its single phases (Figure 5).

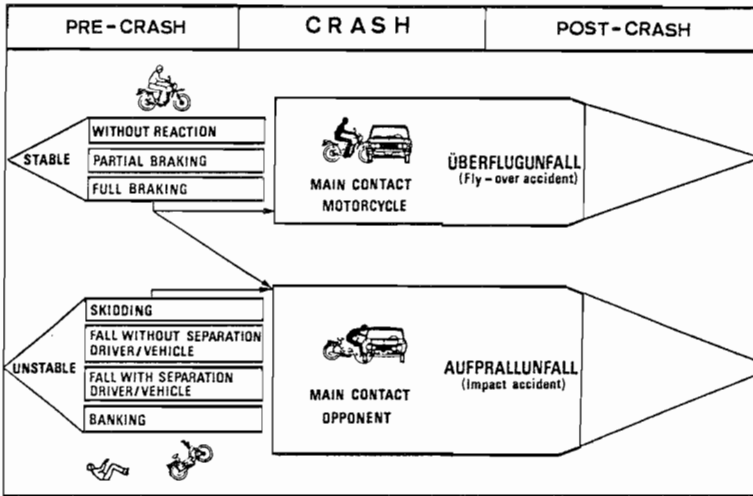

Figure 5

In the first phase, the pre-collision-phase, the pre-conditions are determined for the kinds of motion in the second phase. Especially the cycle can, for reasons of its single-track-construction, already in a falling way drive into the collision phase and thus produce completely other motion sequences, which do not occur with motor-car-accidents /4/.

During the collision phase main differences can be seen in the direct bump of the cyclist against the other vehicle and in the overflight. This phase is decisive for the seriousness of injuries to the cyclist, as the energy is reduced either by the cyclist's hard bump against the other vehicle or by the overflight.

The post-collision-phase then shows the result, that is, whether the cyclist has suffered a bump or whether he was able to destroy his energy by rolling onto the street.

MOTION SEQUENCES AND INJURY PATTERNS

Starting points for developing protective measures are of greatest use during the pre-collision and the collision-phase, as here the course is set for the decision: bump or overflight.

How decisive this difference is shows a glance on the severity of injuries suffered by cyclists, divided into bump and overflight. The real accident sequence shows already clearly that safety measures are only possible, if they influence the cyclist concerning an over-flight with ist reduced strain (Figure 6). The seriousness of injuries increases according to an increase in speed, but the rate of the seriousness after a bump exceeds, in any speed range, the rate resulting from an overflight.

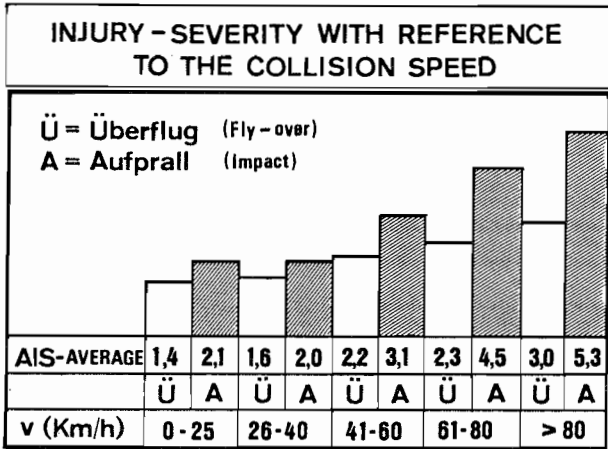

Figure 6.

Which causes can be found for these different motion sequences?

The analysis of the real accident sequence /5/ shows that cyclists on special types of motorcycles were more often able to start an overflight. These types were mainly "enduros" and cross-country-motor-cycles (Figure 7).



Figure 7

With similar collision speeds and similar vehicles the cyclists were much more often able to overfly the other vehicle than the cyclists of normal motor-cycles and light motor-cycles. This result shows that there are technological parameters which influence the path of motion. The knowledge of this then led to experimental and mathematical simulations of the possible influencing parameters and will be explained in the following. Possible parameters might be points which result on the one hand from the geometrical measurements of the motor-cycle and on the other hand from defence reactions of the cyclist himself. If we first ignore the second point, then there is a variation of the parameters which determine the essential measurements and characteristic features of a motor-cycle:

- height of seat
- seating position: influenced by the position and form of bench-seat, handlebar and footrest.
- shape of contact surfaces: tank, handlebar, baffle-pad.

EXPERIMENTAL RESULTS

In the experimental part of the research two series of crash experiments were carried out, which on the one hand very well complemented one another, and, on the other hand, each of which led to important individual results; the "real crash" and the sledge-test.

In the "real test" motor-cycles of the same type were driven against different surfaces of a stationary vehicle (Figure 8).



Figure 8

Besides the decelerations of the motor-cycle the decelerations of the head and the chest of a "50%-Sierra-Dummy" were measured and by means of high speed films a chronological description of all incidents in the first 200 ms was made. The measured decelerations of the motor cycle permit the following conclusions (Figure 9).

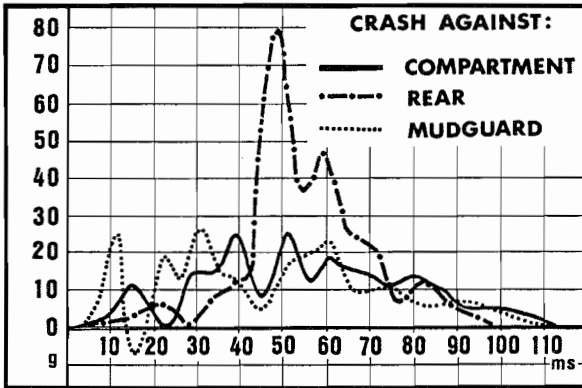

Figure 9

- The form of deceleration sequence of the motor-cycle can be varied theoretically by technological measures, as it is determined essentially by the parts tyre - fork - rim.
- But such a measure would not be successful with regard to the cyclist, as:
 1. The cyclist is connected with the motorcycle only by sitting friction and therefore a soft deceleration cannot be passed on to his body.
 2. The deceleration of the motorcycle is strongly dependent on the geometry and rigidity of the impact-point, as the deceleration sequence with the rear-crash shows.

Here tyre - fork - rim could not deform themselves in the desired way, because the motorcycle has driven under the rear of the car with its front wheel and has only been decelerated by the very hard contact between steering-head and bumper. But there was no reaction to this different deceleration to be seen in the dummy's motion sequence.

So the deceleration has a neglectable influence on the cyclist's motion path.

Yet the chronological description of the single phases provides important hints (Figure 10).

In the upper part of the slide the dummy's activities are noted, in the lower part the deformations and motions of the motorcycle. So both systems can be related to each other. If

you take the case of a collision against the passenger compartment of a motor car with a collision speed of 50 km/h,

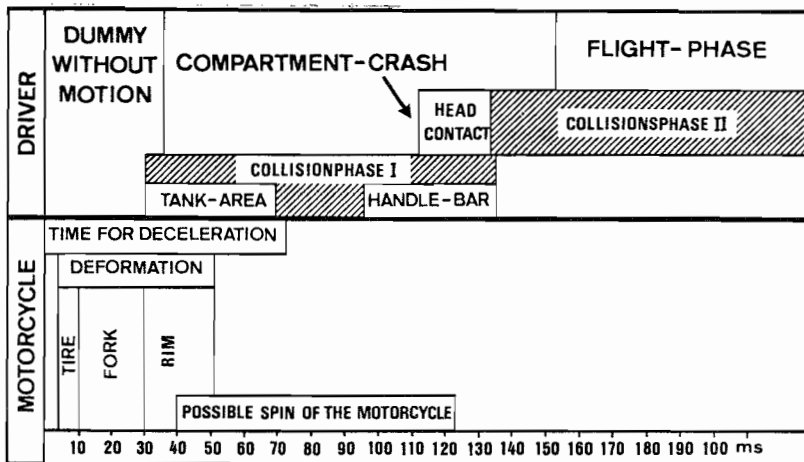

Figure 10 Chronological Description of a 50 km/h Test

then the most important incidents happen during the first 100 ms after t_0 . This is a very short time for measures to have an effect, nevertheless there is the possibility to influence the cyclist's motion path in this time varying some of the construction elements.

The aim of a safety conception was to start an overflight and to avoid the dangerous area roof edge for the cyclist's head /4/.

The first contact after t_0 between dummy and motor-cycle takes places after ca. 30 ms. The lower part of the body bumps against the tank. On varying the shape of the tank it has shown that a tank rising angle of ca. 40° - 45° is the best compromise (Figure 11).

SHAPES OF FUEL-TANKS

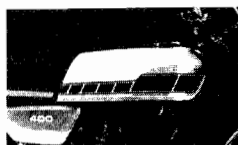

TOO FLAT



TOO STEEP



40°-45°

First a too flat tank does not exercise any reactive power on the cyclist which raises the centre of gravity and, secondly with a too flat tank, the impact of the thighs against the handlebar is very hard, as there is no speed reduction. A steep tank does raise the cyclist's centre of gravity, but also involves a heavy rotation of the upper part of the body around the lower part, which does not remove the cyclist's head from the dangerous area.

The handlebar is influential in two respects. Once the seating position is determined by its shape and second, the handlebar is responsible for serious thigh-injuries, if there is an impact against it. The aim of the improvement must therefore be to find the most suitable seating position for an overflight and to prevent a bump of the lower extremities (Figure 12).

HANDLE-BARS



LOW



CHOPPER



TOURING HANDLE - BAR

Figure 12

Here, too, the middle course in the form of a touring- or cross-country-handlebar has proven to be most suitable. A too flat handlebar, as it can often be found with sporting-cycles, makes the cyclist sit in a very low position, where the position of the head is relatively low in relation to the roof edge of the other vehicle. To raise this very low position of the head by technological measures during the first 100 ms in such a way that the head is removed from the dangerous area roof edge is extremely difficult, if not impossible.

A very high handlebar, also called "chopper-handlebar" creates an optimal seating position, but unfortunately develops characteristic features during the collision sequence, which lead to the body getting caught on the handlebar, and thus

prevent the desired flight path. In addition, the seating height on "chopper-motorcycles" is very low.

MATHEMATICAL DESCRIPTION OF THE MOTION SEQUENCE

All variations described so far have already been carried out on a sledge installation with which it was possible most easily to control the effects of the single parameters. At the same time the motion sequence was calculated in a mathematical simulation programme, in order to obtain the arising powers and decelerations /5/. By means of a converted passenger model with 10 degrees of freedom it was possible to simulate the powers and motions of a cyclist who bumps against a stationary obstacle, a motor-car (Figure 13).

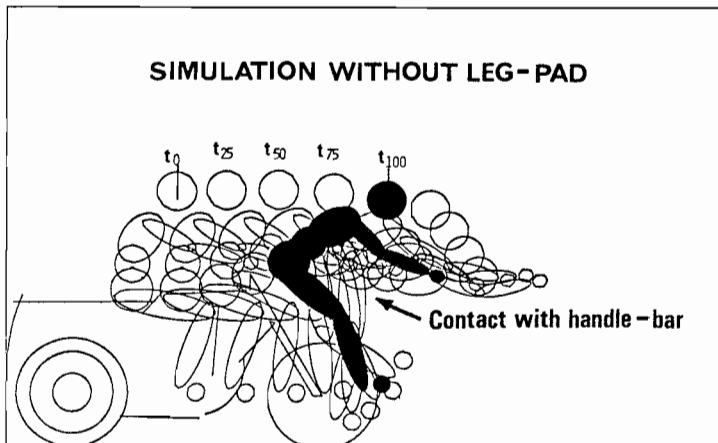

RESULTS

The first positive influence on cyclist's path turned out arithmetically and experimentally after the introduction of baffle-pads in front of the cyclist's legs. Because of these the bad impact of the legs against the handlebar could be prevented. So not only the danger of thigh injuries is averted, but also the body's being caught on the handlebar, the so called "flick-knife-effect", can be eliminated in this way. An optimal function of this pad also includes absolutely necessary support of the entire lower leg. The full effect of the leg-pad could be observed afterwards with the combination with a touring-handle-bar, as in this case the flight path was also influenced (Figures. 14/15).



Figure 14 Test without baffle-pad

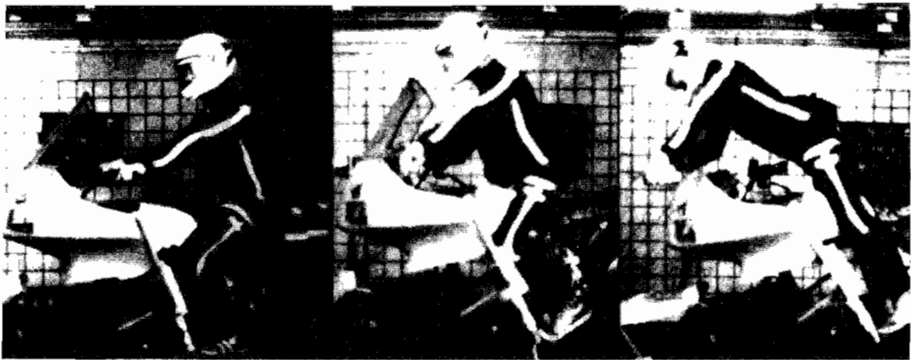

Figure 15 Test with baffle-pad (leg-pad)

The dummy's body stretched and the bumping point of the head was some centimetres higher than it had been in the experiments without pad and with a sporting-handlebar.

The possibility of influencing the flight path resp. the search for safening-elements, which have been introduced so far, has not yet come to an end, but will be continued within the HUK-accident-research.

In the last few years there was by no means a lack of suggestions how to fix the cyclist by hold-back-devices to the vehicle resp. to minimize somehow the risk of being caught on the bar. Looking at the patent applications one can find constructions which try, some in a futuristic and others in an amateurish way, to force safety on the motor cycle. The probability of realizing these inventions is very low, as mostly the effect of the new safety-element is uncertain or the conception of the entire motor-cycle would have to be changed. But the situation might be different with an additional safety element which has actually been applied for the car, namely the airbag. At present the airbag is one of the few car-safety-elements which could also have an effect on motor-cycles, but only if it is used additionally on the basis of the measures discussed above and if it does not alter the characteristic features of the motor-cycle. In order to fulfil these requirements the effect of the airbag has to be extended: concerning the motorcycle - apart from cushioning the impact - an influence on the flight path might be possible by means of the airbag. Compared to the car-airbag there are other priorities for the motor-cycle-airbag:

1. Influence on the flight path and the driver-movement
2. Cushioning of the impact between driver and other vehicle.

Already 10 years ago experiments were made /6/ with airbags on motor-cycles, at that time mainly with the aim to protect the cyclist from the bump against the other vehicle. They did not consider an influence on the flight path, so that the shape of the airbag at that time had to be orientated to a support. Furthermore this airbag had a volume of 200 l and was thus very difficult to be filled up.

A further development of those ideas has not become known, except for an inflatable protective suit for the cyclist himself, but which has never been able to fulfil its function entirely, as the filling-up was done with compressed air and therefore took longer than 150 ms. This time is long enough to protect the cyclist in a fall, but not in a collision during which the decisive incidents take place during the first 100 ms.

Fortunately the technology of the airbag has been developed further because of the activities on the motor-car sector, so that the basic knowledge can be taken over. Today the filling-up of the airbag in its third generation, is done by burning up solid fuel and no longer by compressed air, as in the first generation, or by hybrid liquid gas, as in the second generation. This defined burn-up with controlled expansion enables inflating times, dependent on the temperature of ca. 30 ms /7/. As the chronological sequence of a motor-cycle

collision is known from the previous experiments, it can be said that this time is long enough to realize the protective effect.

The volume of the bag, in the motor-car ca. 60 l, won't certainly be sufficient for the motor-cycle. Further points of improvement are also the shape of the airbag and how to pack it on the cycle in order to achieve the two priority aims as well as possible.

The release of the fuel and the electronic control equipment have not been mentioned deliberately in this list. These partial components of the system are not yet important, for first it must be shown how the best influence on the cyclist can be achieved by coordinating all measures and only then the solution of these partial problems can be tackled which do not seem to cause substantial problems.

On the basis of these theoretical considerations and the preparatory work already done a first serie of experiments has been started in order to observe the effect of the airbag experimentally. Figures 16 and 17 show the simulation of a collision with the sledge facility mentioned previously. The dummy is slightly raised by the airbag and thus is also removed from the dangerous area of the roof edge. In the further course the airbag can soften the impact, too, as it moves together with the body towards the vehicle.



Figure 16



Figure 17

Further research has to show which of the designs mentioned above is most effective for the motorcycle and if there is a realistic chance to influence the flight-path. Other problems, such as economical aspects or questions concerning bag-activation safety will have to be examined in following phases. An other future prerequisite would be that airbag-system costs are reduced, as prices of about DM 2.000,- as they are charged for a motor-car-airbag, are of course illusory for motorcycles.

Nevertheless, the search for technological safety elements must not fail because of these hindrances, for the more the airbag is accepted in the car the more certainly the costs of the system might be reduced on the long run, and it is not unrealistic that also the motorcycle could gain from.

SUMMARY

The complex nature of the motorcycle accidents requires an exact knowledge of motion sequences and accident characteristics for the search for technological measures aiming at an increase of safety. With some types of motorcycles as the light-powered-motor-cycles like Mofa, Moped, Mokick there seem to be only limited possibilities to influence

safety by technological measures . This, on the one hand, depends on the design and their frame stability, on the other hand on the collision mechanism, as these motorcycles are mostly impacted by another vehicle.

Concerning heavy motorcycles the prospects seem more positive, even if there cannot be a total protection. Here, on the one hand, the collision of the motorcycle against the other vehicle is dominant and the design of the motor-cycle permits additional technological measures which can increase safety.

On the basis of the analysis of real accidents and of experimental and mathematical simulations the following requirements have been worked out:

An effective safety element for the cyclist has to influence his motion path. Only if the direct impact against the other vehicle can be avoided the risk of being injured is reduced. The sum of all possible measures is summarized once again in the last slide (Figure 18). When bumping against a motor-car the risk of suffering serious or fatal injuries can be reduced essentially by

- a seating position as high as possible
- a touring handlebar combined with a baffle-pad in front of the legs
- an optimized tank
- an anti-dive-system which does not make the cyclist's body dive during an emergency braking
- and perhaps an additional airbag system.

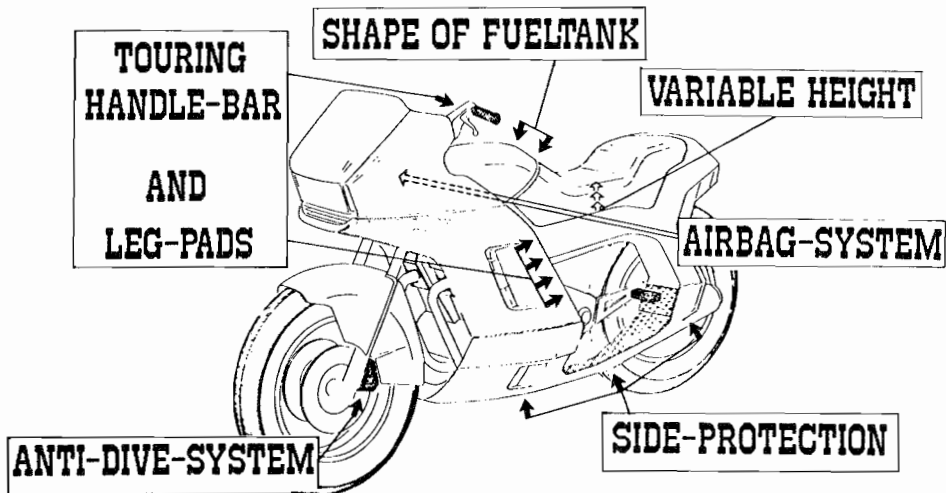

Figure 18

Furthermore the cyclist's legs can be protected additionally by integrated protective bars in side collisions and falls.

How both realistic and easily to be carried out the discussed technological measures are, can be seen in the latest models of some motor-cycle producers who have already realized attempts of some safety elements. But as an improved protective effect is only guaranteed by the combination of all elements suggested; a lot of developmental work is yet to be done and it is to be hoped that it won't take too long until all technological safety measures which are already known will be realized.

CONCLUDING REMARKS

The authors are indebted to all the member insurance companies of the HUK-Verband in particular for making their claims records readily available for this study, to the staff of the AZT for their help with the tests, and to the HUK staff who carried out accident analysis and evaluation work. The authors also owe a debt of gratitude to all the companies whose support made it possible to execute the various tests.

REFERENCES

- /1/ HUK-Verband
Unfallcharakteristik und Verletzungsfolgen bei Mofa-
Unfällen
HUK-Verband, Büro für Kfz-Technik, März 1983
- /2/ Langwieder, K., Klein, H., Zipfel, H-D.
Untersuchung von 1000 Leichtkraftradunfällen in Bayern
Noch nicht veröffentlichte Untersuchung
- /3/ Danner, M., Langwieder, K., Polauke, J., Sporner, A.
Schutzkleidung für motorisierte Zweiradfahrer
Bundesanstalt für Straßenwesen Dezember 1984
- /4/ Langwieder, K.
Collision Characteristics And Injuries To Motorcyclists
And Moped Drivers
21. Stapp Car Crash Conference, 1977
- /5/ Sporner, A.
Experimentelle und mathematische Simulation von Motor-
radkollisionen im Vergleich zum realen Unfallgeschehen
Dissertation TU München 1982
- /8/ Hirsch, A.E., Bothwell, P.
Air Bag Crash Protection for Motorcycle Application
N.H.T.S.A. 1973
- /7/ Daimler-Benz AG
Luftsack und Gurtstrammer für Mercedes-Benz Pkw
Technische Information